

INSTALLATION INSTRUCTIONS



Combi 185 BP/Combi 185 BP XL

TABLE OF CONTENTS

About the Product	3
Transportation and Storage.....	3
Directions/Safety Instructions.....	3
Product Description	4
Installation	5
Setup	5
Connecting to a Water Main	5
Connecting to Condensate Drain	5
Connecting Ducts	6
Ducting System	7
Insulation of Ducts in Cold Lofts	7
Insulation of Ducts in Heated Spaces	8
Electric Water Heater/Sensor/Anode.....	8
Electrical Installation	9
System Inspection and Fine-Tuning	9
Optimal Fine-Tuning of the System.....	9
Requirements to the Hot Water Circuit	9
Initial Operation of the Water Circuit	9
Cooling Circuit.....	9
Heat Exchanger Operation.....	10
Energy-Saving Tips.....	10
Fan Operation Tips.....	10
Rechecking	10
Diagrams	11
Electrical Diagram for Optima 312 with ES 960 Circuit Board	11
Circuit Board ES 960 for Optima 312	12
Flow Diagram	13
Hydraulic Connections.....	14
Spare Parts	15
Declaration of Conformity	16

ABOUT THE PRODUCT

Transportation and Storage

As a rule, the unit should be stored packaged in an upright position and without water. Transported with care and over short distances, the unit may be tilted to up to 45 °C.

Transportation and storage may take place at temperatures between -20 and +70 °C.

Transportation with a Forklift Truck

When the heat pump is transported with a forklift truck, it must be placed on the provided base mount. Lifting must be conducted slowly. As the unit has a high centre of gravity, the unit must be secured so as not to topple during transportation.

Transportation with a Sack Trolley

Secure the unit against slipping on the sack trolley. Do not use water pipe connections, etc. for transportation purposes. Make sure that the sack trolley does not damage the cabinet and the connectors.

Unloading

To prevent damage, offload the unit onto a level surface.

Directions/Safety Instructions

- The construction of the unit conforms to all EU regulations (see also the CE certificate).
- Take measures against fire during maintenance work that has to do with opening the coolant circuit, in particular, when the work involves fire (soldering, welding, etc.)
- Before starting work on the unit, remember to always disconnect all electrical connections.
- When connecting the unit, observe all applicable laws and regulations.
- The water used must be potable grade. A reduction valve should be installed if the water pressure is high.
- All connections for potable water must be certified.

Note: *Work should only be done by a certified contractor.*

Product Description

Use

The Combi 185 BP/Combi 185 BP XL BP/Combi 185 BP XL is a combined ventilation unit and domestic water heat pump which can be used for:

- Heating hot domestic water;
- Ventilating a dwelling;
- Supplementing the heating of the dwelling with heated supply air when the heat pump is not busy producing domestic hot water.

Description

The Combi 185 BP/Combi 185 BP XL is a ready-to-connect unit whose most important components are: cabinet, tank, coolant, atmosphere and water circulation components as well as a control unit and regulating and monitoring unit. The unit can be connected to an internal heat exchanger with an area of 0.8 m² which allows connection to an external boiler, a solar heating system, etc. In the heat pump, the Combi 185 BP/Combi 185 BP XL utilises the residual heat in the extract air to either heat the supply air or to produce domestic hot water.

The Combi 185 BP/Combi 185 BP XL unit can heat domestic water corresponding to a family's hot water needs all year round. The used and cooled air is expelled outside via the discharge duct.

The tank has a built-in immersion stem which makes it possible to regulate temperature in the tank by sensors placed at the bottom and in the middle of the tank. The Combi 185 BP/Combi 185 BP XL has an electric heating element installed in the tank which acts as a backup.

Output

Combi 185 BP/Combi 185 BP XL can, in the course of 24 hours, heat 380 litres of domestic water to a temperature of 55 °C. This can, of course, vary depending on the temperature of the heat source, the temperature of the cold water and the drainage pattern. The integrated electric immersion heater, which has an output of 1 kW, can be engaged at peak loads. The Combi 185 BP/Combi 185 BP XL only consumes approx. 30% of the electric energy that would be consumed by a directly heated tank.

Coolant Circuit

The coolant circuit is a self-contained circuit where the R134a HFCKW-free coolant acts as energy carrier.

Heating Module

Heat in the air is removed by the condenser at low evaporating temperatures and transferred to the coolant. The coolant is sucked out in the form of steam by a compressor and compressed at a higher pressure/temperature and then transported to either the domestic water heater of the condenser, and/or its supply air duct. The energy which the compressor has pumped into the coolant and the part of the energy that comes from the condenser are transferred here to either the water or the air that is being heated. In the process, the coolant condenses and reverts to a fluid state.

The high pressure in the coolant subsequently goes through an expansion valve where it is reduced, and the coolant can once again absorb heat from the extract air via the evaporator.

Process

The control unit (Optima 312) starts the compressor shortly after hot water starts to be used and as soon as the sensors detect a temperature drop in the tank. The compressor runs until the entire tank has once again reached the set temperature.

The Combi 185 BP/Combi 185 BP XL will normally be able to satisfy the needs for hot water of an entire family. If a situation comes where the Combi 185 BP/Combi 185 BP XL is not able to produce enough hot water, the immersion heater in the tank can be activated manually via the control unit.

This will make it possible to produce double the amount of hot water. The immersion heater can be set to the desired heating temperature of the water in the upper section of the tank. (Only use the immersion heater at peak loads as it consumes more energy than the compressor).

Defrosting

When the temperature difference between the temperature prior to the cooling coil and the temperature of the cooling coil itself becomes too large, which occurs when there is ice formed on the cooling surface, the unit will begin to defrost.

The supply air ventilator and the electric heating coils will disengage. The discharge air ventilator will continue to run together with the compressor, which will send hot gas directly into the evaporator until the ice melts and the cooling coil reaches a temperature of around 5 °C, depending on the temperature that has been set in Section 50. The supply air fan and the electric heating coil will then re-engage.

Scope of Delivery

- Combined ventilation unit and domestic water heat pump with a control unit.
- Installations Instructions and Instructions for use

Accessories

- Replacement filters
- Temperature sensor for solar cells/central heater/geothermal pipes
- Electric preheater
- Electric or water-based reheater
- Anode

INSTALLATION

Setup

Only set up the unit in *frost-free premises*.

The premises should fulfil the following prerequisites:

- Room temperature of between 8 and 35 °C for operation using room air
- Good insulation to adjoining premises
- Condensate drainage
- No abnormal dust load in the air
- Solid foundation (approx. 500 kg/m²)

To ensure problem-free operation of the unit and provide access for repairs and maintenance, it is recommended to keep 0.6 m clear in front of the unit.

On setup:

Remove the packaging material from the pallet

1. Remove the corner protectors
2. Remove the transport mounts on the pallet
3. Lift the unit off the pallet and position it
4. Align the unit by turning the adjustable support legs

KVM-Genvex A/S always recommends that you carefully plan where to set up your Genvex product in relation to the position of any living room. Since this is an engineering product fitted with fans and/or a heat pump, this may result, on rare occasions, in combination with unsuitable installation conditions, in unsatisfactory noise or vibration. As a rule, we always recommend that the system be installed so that it is not immediately adjacent to a bedroom. As regards the fastening of the Genvex system to the building structure, we simultaneously recommend that it be fastened to a heavy structure like, e.g. concrete.

Also make sure that sound or vibrations cannot be transmitted through materials that are in contact with the technical system. If there is a risk of transmission of sound and vibrations, we recommend the additional installation of anti-vibration materials and the soundproofing of the setup room.

Connecting to a Water Main

During installation, to ensure that there is sufficient pressure and water where the water is drawn, take into consideration the pipe dimensions in relation to the existing water pressure and pressure loss.

The aspects of the installation that have to do with water must comply with the local HWS regulations. The water pipes can either be made hard or flexible. However, they must be approved for drinking water. Take into consideration the corrosive properties of the pipes to avoid damage.

As with all pressurised containers, the tank of the unit must be fitted with an approved safety valve and an approved check valve on the supply side (always check the local requirements).

The inflow of fresh cold water and the outflow of hot water take place underneath the tank (3/4" RG connection). The maximum operating pressure is 10 bar, and the maximum operating temperature is 65 °C.

If necessary, the supply pipe must be fitted with a pressure reduction valve and possibly with a filter.



When fitting the piping in the dwelling, avoid contaminating the pipes. If required, flush the pipes with clean water before connecting the unit.



When fitting pipes, take care not to twist the pipe connections. Use a pipe wrench to apply counter pressure.



If recirculation is not used, make sure that the recirculation pipe connection is fastened securely.

Connecting to Condensate Drain

Quite a bit of condensate will form due to the cooling of the air that passes through the heat exchanger. The condensate drain is fitted with a hose which guides the water to a proper hose.

Depending on air humidity, the flow can reach 0.5 l/h.

It is a requirement to fit the drain with a sealed water trap with a minimum water head of 100 mm in order to allow the water to drain from the unit unhindered.

If the unit is not fitted with such a water trap, the water will not be able to drain from the tray due to negative pressure, which can result in water damage.

It is also possible for the unit to suck in air via the drain and since the drain contains ammonia vapours, this will damage the cooling system before long.

Failure to fit the water trap properly will void the warranty.

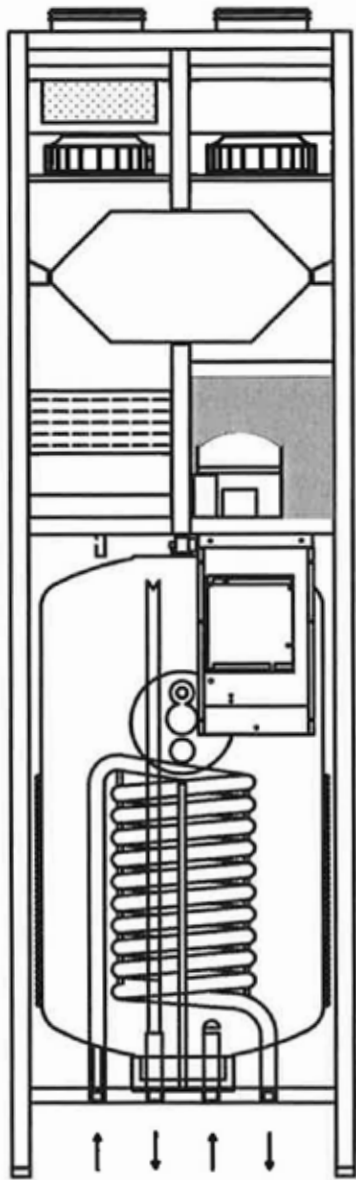

Fresh Air

The fresh air may not be polluted with aggressive substances (such as ammonia, sulphur, chlorine) as these can damage the components of the cooling system.

Connecting Ducts

All duct connectors carry a yellow sticker which specifies which ventilation duct is to be connected to the various connectors.

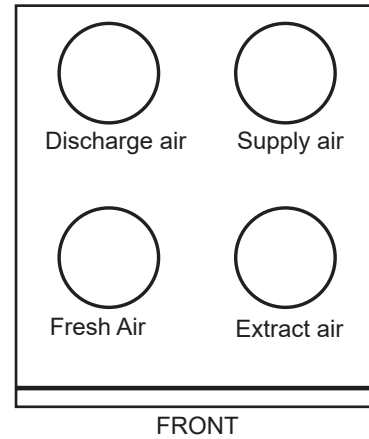

Connecting Supply Air

The ducting system leading from the unit to air injected in living quarters.

Connecting Extract Air

The ducting system leading from the wet rooms to the unit.

Connecting Fresh Air

The ducting system leading from the fresh-air roof cowl/ fresh-air grating outdoors to the unit.

Connecting Discharge Air

The ducting system leading from the discharge air roof cowl/discharge air grating to the outside.

Ducting System

To build an airtight and durable ducting system, we recommend that the ducting system be made from spirally flanged pipes using fittings with a rubber ring seal.

To keep the noise level from the unit satisfactorily low, always mount silencers on the supply air and extract air ducting systems between the unit and the first air intake and extract valves.

To prevent the air intake and extract valves from generating any noise, it is recommended that air speeds in the ducting be kept sufficiently low.

When place is found for fresh air and discharge air roof cowls/air gratings, avoid short-circuiting the two air streams so that the discharge air is sucked back in. To achieve maximum comfort in the dwelling, it is recommended that roof cowls/air gratings be placed on the northern or eastern side of the building. **Minimum distance between roof cowls/air gratings: 3 m.**

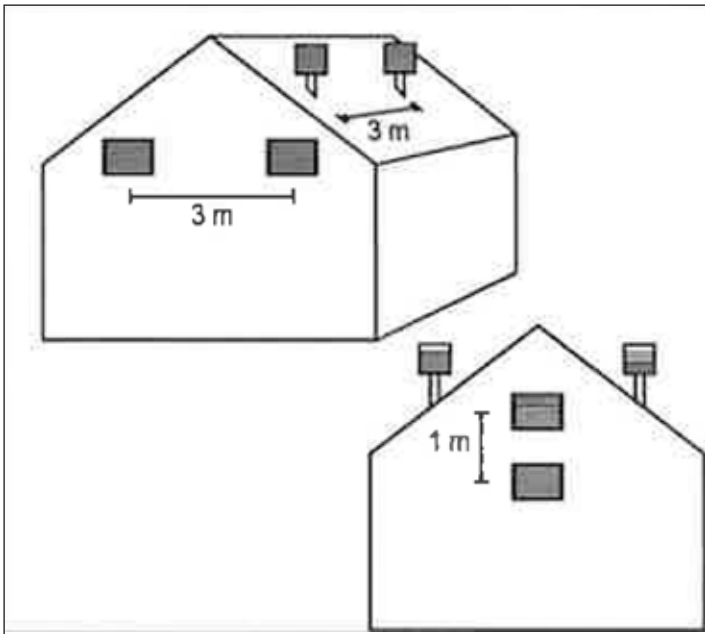

Insulation of Ducts in Cold Spaces

To take advantage of the high recovery potential of the units (efficiency), it is necessary to insulate the ducts properly.

Genvex recommends, as follows:

Supply Air and Extract Air Ducts

To minimise heat loss from the ducting system in cold lofts, insulate the supply air and extract air ducts with a minimum of 100 mm insulation. If insulation form alternative (A) is used, it is recommended that it takes the form of two layers of 50 mm lamella mats with paper or foil externally and staggered joints between the two layers. If the ducts are laid on the rafter foot, alternative B may be used. The insulation must always be tightly packed around the ducts.

Fresh Air and Discharge Air Ducts

It is recommended that fresh air and discharge air ducts be insulated with a minimum of 50 mm insulation followed by aluminium foil. The fresh air duct is insulated to prevent warm air in the loft from heating up the fresh air in the summer.

To avoid condensation damage, make sure that the place where the discharge air duct passes through the roof or the gable end is sealed well.

Refer to your local distributor for guidance on national insulation directives.



Duct insulation, alt. A

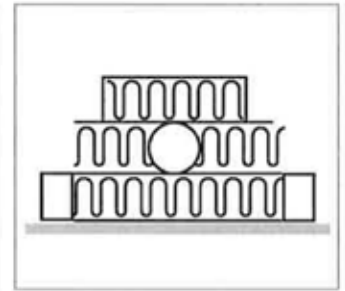

Duct insulation, alt. B

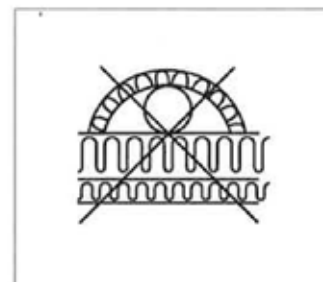

Incorrect duct insulation

Insulation of Ducts in Heated Spaces

Genvex recommends, as follows:

Supply Air and Extract Air Ducts

If the loft is warm, insulate the supply air and extract air ducts with 50 mm of insulation followed by aluminium foil.

Supply air and extract air ducts passing through heated spaces in dwellings do not require insulation unless cooling, a bypass or an earth heat exchanger is used. In this case, the supply air duct must be insulated.

Fresh Air and Discharge Air Ducts

Insulate the fresh air and discharge air ducts in warm lofts and heated rooms in dwellings with a minimum of 50 mm insulation. Also cover the insulation externally with plastic film or aluminium foil to avoid formation of condensate in the insulation. Refer to your local distributor for guidance on national insulation directives.

We recommend 100 mm of insulation on the fresh air duct when an earth heat exchanger is used.

Optional Connection of Heating Coil

The tank is fitted with a 0.8-m² heating coil. The heat exchanger is enamelled externally.

The connection is 3/4" RG. A sensor controlling external connections such as solar cells, an oil burner or a wood burning boiler can also be mounted in the sensor pocket. The maximum diameter of the sensor is 6 mm.

When fitting the piping in the dwelling, avoid contaminating the pipes. If required, flush the pipes with clean water before connecting the unit.



When fitting pipes, ensure that the pipe connections are not twisted. Use a pipe wrench to apply counter pressure.

If recirculation is not used, make sure that the recirculation pipe connection is tightened properly.

Water Connection

The following connectors are placed underneath the unit:

- Condensation drainage hose
- 3/4" RG branch pipe for: Cold water/Recirculation/Hot water
- 3/4" RG branch pipe (2 units) for a solar heating coil (S models only)

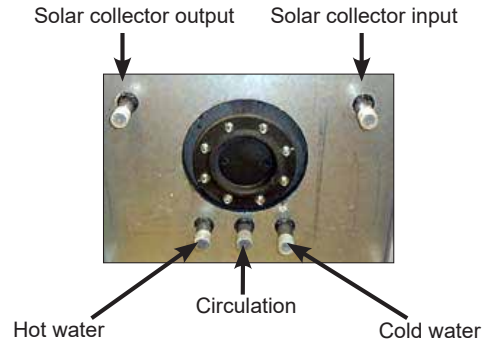

Electric Water Heater/Sensor/Anode

These are placed in the middle on the front, behind the lowermost front part and underneath a steel plate.

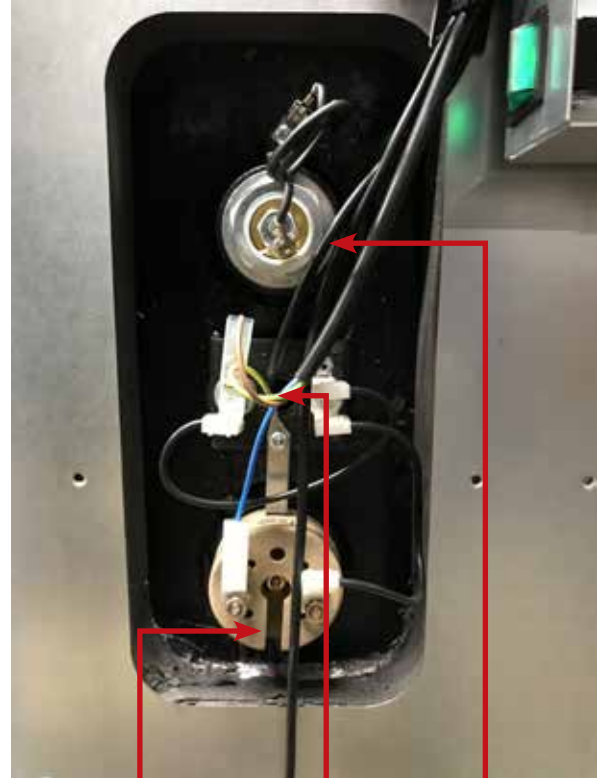

Electrical water heater

Thermostat

Anode

Electrical Installation

The connection to the mains must be performed by a certified electrician. (See the enclosed electrical diagram).

The cable connecting the unit to the Design control panel must be a 4-conductor, 0.25-mm cable with a maximum length of 50 m.



The unit may only be operated with a full tank.



The unit must always be disconnected from the electrical power source before the front hatch is dismantled. Once the unit has been disconnected from the mains, wait until the fan has come to a standstill before opening the hatch.



Do not drill any holes in the unit.

System Inspection and Fine-Tuning

To ensure optimal operation of the system, fine-tune it first using professional air-measuring equipment.

Check the following points, while keeping in mind that the system can be put into operation before the fine-tuning.

1. Check that the system has been mounted correctly and that all ducting has been insulated in accordance with the instructions.
2. Check that the various hatches can be opened so that it is possible to service and maintain the unit.
3. Check that the filters are clean (they can be dirty after installation), and replace if necessary before fine-tuning.
4. Check that the condensation drainage is mounted correctly with a water trap and that this is protected against frost.
5. Pour 1 l of water into the condensation tray and check that it flows away without impediment via the condensation drainage hose.

Default setting if the system is started up prior to fine-tuning:

- Adjust all supply air valves so that the valve which is closest to the unit is open at 3 turns from the closed position, while the one furthest away is open at 8 turns from the closed position.
- Then open the valves in between at 4 to 7 turns depending on how close they are to the unit.

Optimal Fine-Tuning of the System

Use air-measuring equipment. Check that all 5 items in the section above have been carried out before performing the fine-tuning. Then put the system into operation.

Set up the system for basic ventilation, i.e. speed 2. To reduce energy consumption as much as possible, first adjust the overall atmospheric volume to the desired level by changing the speed settings in the Service Menu.

Then fine-tune the supply air and extract air valves with the air-measuring equipment. Remember to lock the valves when performing the fine-tuning and to turn the conducting plate on the supply air valves so that air blows in the right direction.

Finally, recheck and fine-tune the overall atmospheric volume by adjusting the speeds for Step 2 in the Service Menu. Then adjust Step 1 and Step 3 to an appropriate interval in relation to Step 2.

Requirements to the Hot Water Circuit

The following materials can be used for the hot water installation:

- Copper
- Stainless stain
- Brass
- Synthetic materials

This naturally depends on the materials that have already been used in the water circuit (of the dwelling). Incorrect material combinations may result in corrosion damage.



This requires particular attention when galvanised components and components containing aluminium are used.

Initial Operation of the Water Circuit

- Fill the tank via the connector spigot and then air it out by leaving one of the uppermost hot water spigots open until no more air comes out.
- Recheck the entire water circuit for leaks.
- Connect the unit to the mains.

Inspect all connections of the water circuit for leaks after start-up.

Cooling Circuit

The unit is delivered in running order. No work needs to be done on the cooling circuit. The control unit will automatically assume control of all functions and start up the compressor, fan, etc. in order to maintain the set water temperature.

Heat Exchanger Operation

(S models only)

Heating Boiler

Heat exchanger operation is used if you, for example, only want to heat water via an external heating boiler in the winter (an oil burner, for example). Set the unit to the lowest acceptable water temperature, and it will then function as an emergency back-up. Afterwards, it will be the thermostat of the oil burner that will determine the heating of the water.

This mode of operation requires the installation of an extra sensor in the tank for controlling the boiler. See the section: Optional Connection of a Heat Exchanger. The maximum water temperature must be limited to 65 °C. The temperature can be exceeded for short periods of time, for example, in connection with disinfection.

If the boiler is to function as an extra heat source for the unit, the temperature of the thermostat of the boiler should be set about 5 °C lower than the thermostat of the unit itself. This will ensure that the boiler is only operating when water consumption cannot be covered by the unit. When the unit is put into operation, it is necessary to ensure that sensor values are set as desired.

Wood burner or solar collector

This optional operational connection can be used if the function of the unit is to be supported by a wood burner or a solar collector installation.

Sensor T9 (see the diagram on the next page) measures the temperature in the wood burner or the solar collector. If the temperature is higher than the water temperature in the tank, it is possible for the control unit to activate a circulation pump which will circulate water through the coil in the tank, thereby heating the water. Hysteresis can be set up at 0-5 °C. Maximum temperature is 60 °C. Above this temperature, the control unit will disengage the pump in order to protect the tank.

Energy-Saving Tips

Do not set the water temperature higher than necessary. The lower the temperature, the higher the efficiency of the unit. Only use high temperatures when necessary

Fan Operation Tips

Do not ventilate more than necessary. Over-ventilation often results in very low humidity inside the dwelling, which causes discomfort. In addition, it is a waste of energy to over-ventilate. However, always make sure that there is compliance with the required minimum atmospheric volume.

Rechecking

After installation, we recommend that you check that all connections are water and airtight and that condensed water will flow off without a hindrance.

For maintenance, see the instruction manual.

For troubleshooting, see the instruction manual.

DIAGRAMS

Electrical diagram Optima 312 with ES 960 Print

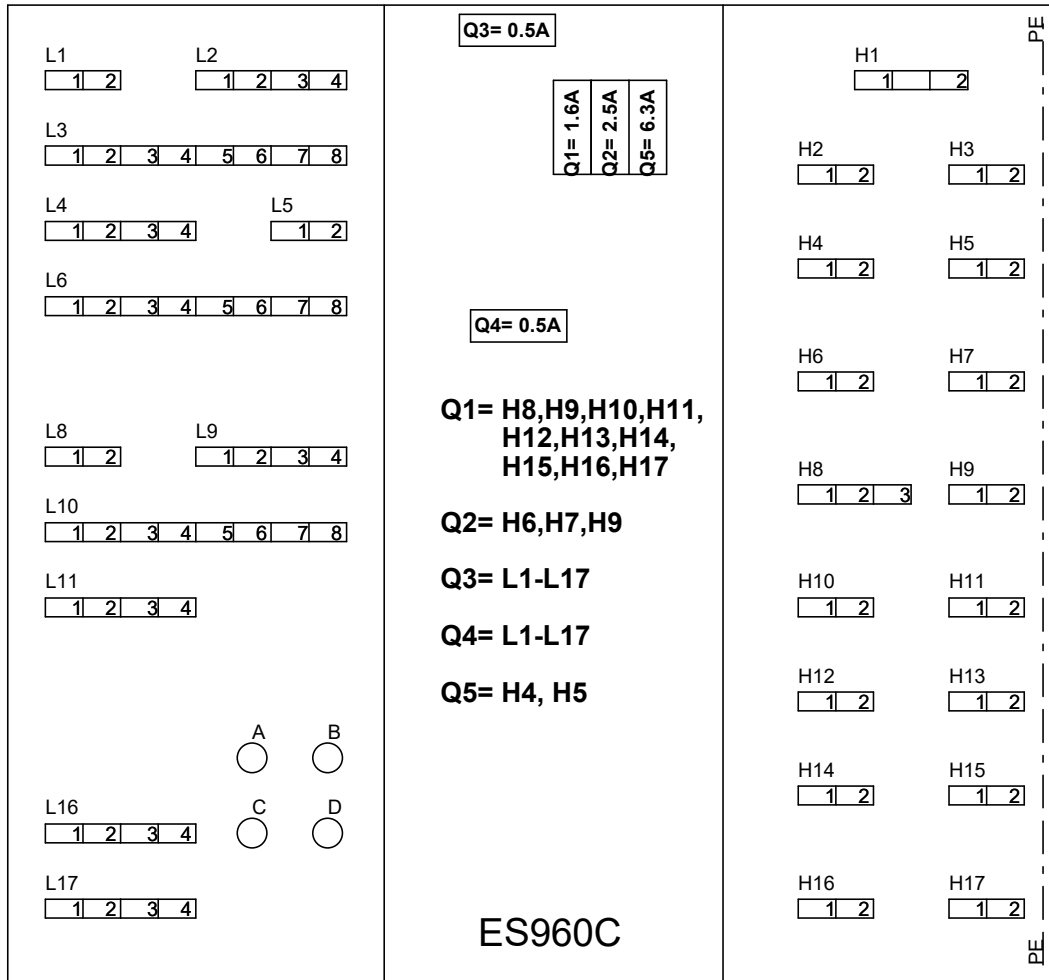

- A = LED Flash - Power on
 B = LED Flash (20 Second intervals) - Communication to Optima Display
 D = LED Flash - Modbus Communication
 Q = Fuse
 SV = Solenoid valve

- L1 = Potential free input for optional:
 Humidistat, Extractor hood ,CO2
 L2 = Optima Display
 L3 = Sensors T1,T3,T4,T7
 L4 = Humidity sensor P1
 = Demand CTRL B1
 L5 = Sensor T2S
 L6 = Sensors T5,T6,T8, T9
 L8 = External stop
 L9 = Not in use
 L10 = Modulating Pre / Reheating
 L11 = 0-10V Control signal
 Motorvalve
 Reheating
 0-10V External bypass
 L16 = Modbus
 L17 = 0-10V extract air fan and
 0-10V supply air fan

- H1 = Mains connection 230 VAC
 H2 = (R2) Electric immersion heater 230VAC
 H3 = (R3) On/Off Electric Pre/reheater 230VAC
 H4 = (R1) High pressure switch
 H5 = (R1) Compressor 230VAC
 H6 = (R10) Power supply Motorvalve Reheating,
 External Bypass 230VAC
 H7 = (R10) Fan, extract air 230VAC
 H8 = (R12) Belimo CM230-F-R ON/OFF Bypass 230VAC
 H9 = (R10) Fan, supply air 230VAC
 H10 = (R4) SV Defrost 230VAC
 H11 = (R7) Extra Cooling 230VAC
 H12 = (R5) SV Water heating mode 230VAC
 H13 = (R5) SV Equalization valve 230VAC
 H14 = (R6) SV Room heating mode 230VAC
 H15 = (R6) SV Equalization valve 230VAC
 H16 = (R8) AUX relay 230VAC
 H17 = (R9) AUX relay 230VAC

Print ES 960 to Optima 312

Potential free input
for optional:
Humidistat,
Extractor hood,
CO2

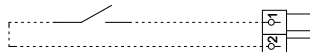

Optima Design



Sensor, supply air



Sensor, fresh air

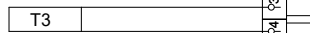

Sensor, exhaust air

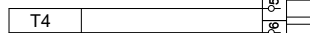

Sensor,
top hotwater cylinder



Demand CTRL B1

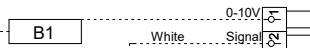

Humidity sensor P1

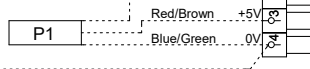

Sensor, extract air

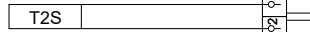

Sensor
before evaporator



Sensor, evaporator



Sensor,
bottom hotwater cylinder



Sensor
solar collector / option



External stop

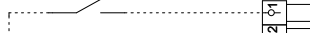

Not in use



Modulating
Preheating



Modulating
Reheating

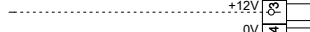

Control signal
Motorvalve
Reheating

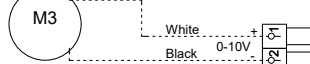

External Bypass

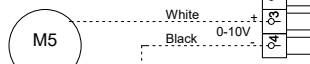

Modbus



EC fan
Extract air



EC fan
Supply air

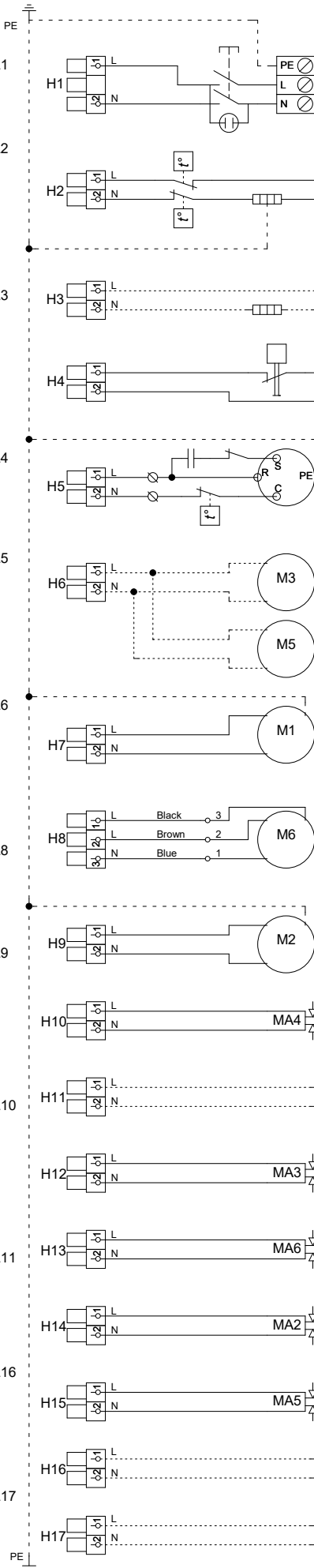
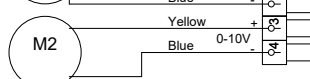

Mains connection
1x230VAC, L-N-PE
Max: 13A

Electric immersion
heater 1000W

Electric Pre/re-heater
Max 1200W

High pressure switch

Compressor

Power supply
Motorvalve
Reheating

External bypass

EC fan
Extract air

Bypass
Belimo
CM230-F-R
ON/OFF

EC fan
Supply air

Solenoid valve
Defrost

Extra cooling
1x230V 50Hz
ONLY control current

Solenoid valve
Water heating mode

Equalization valve
Water heating mode

Solenoid valve
Room heating mode

Equalization valve
Room heating mode

Aux. relay R8
1x230V 50Hz
ONLY control current

Aux. relay R9
1x230V 50Hz
ONLY control current

Flow Diagram

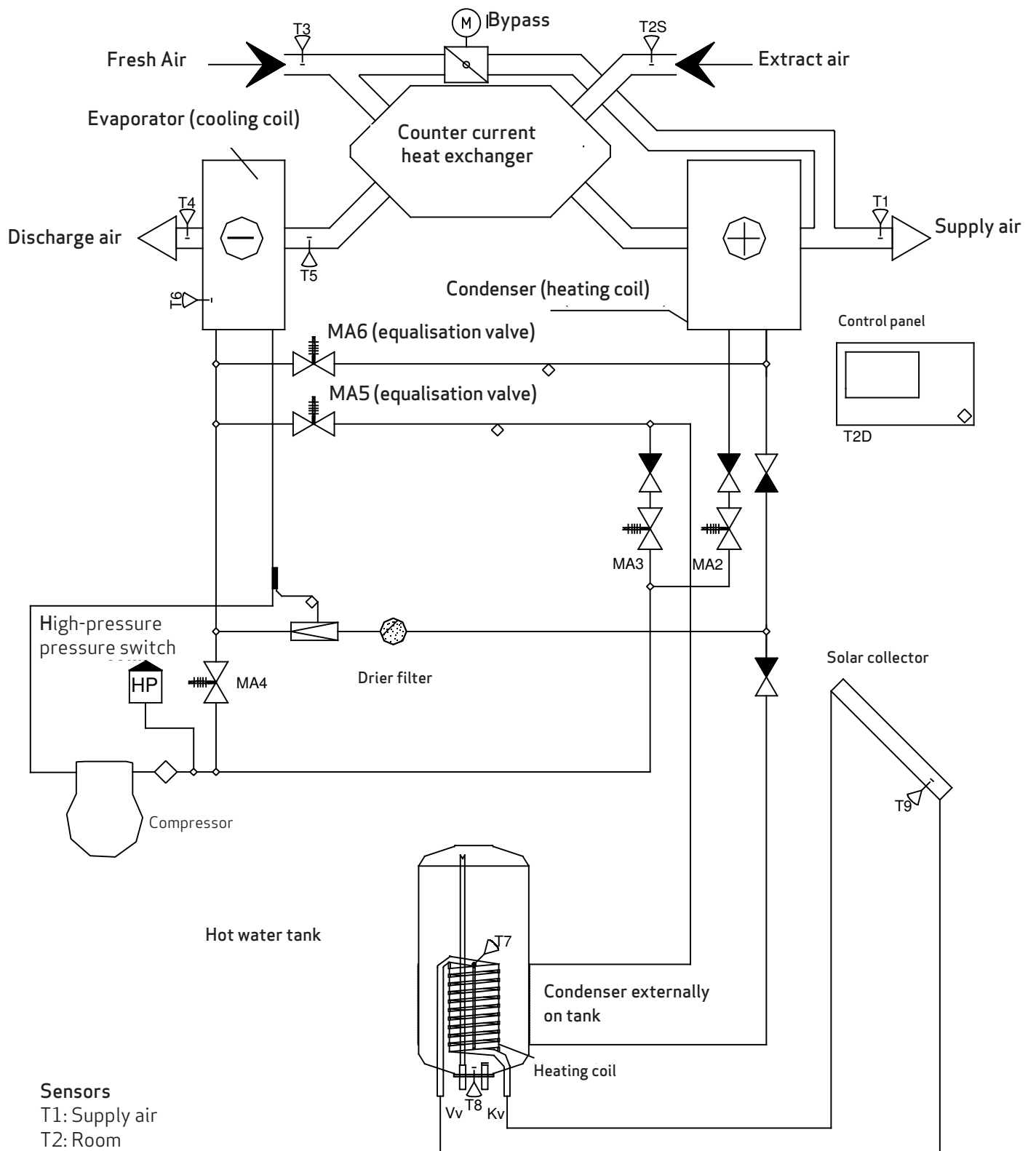

Sensors

- T1: Supply air
- T2: Room
- T3: Fresh Air
- T4: Discharge air
- T5: Before cooling coil
- T6: Cooling coil
- T7: Tank, top
- T8: Tank, bottom
- T9: Solar collector

Hydraulic connections

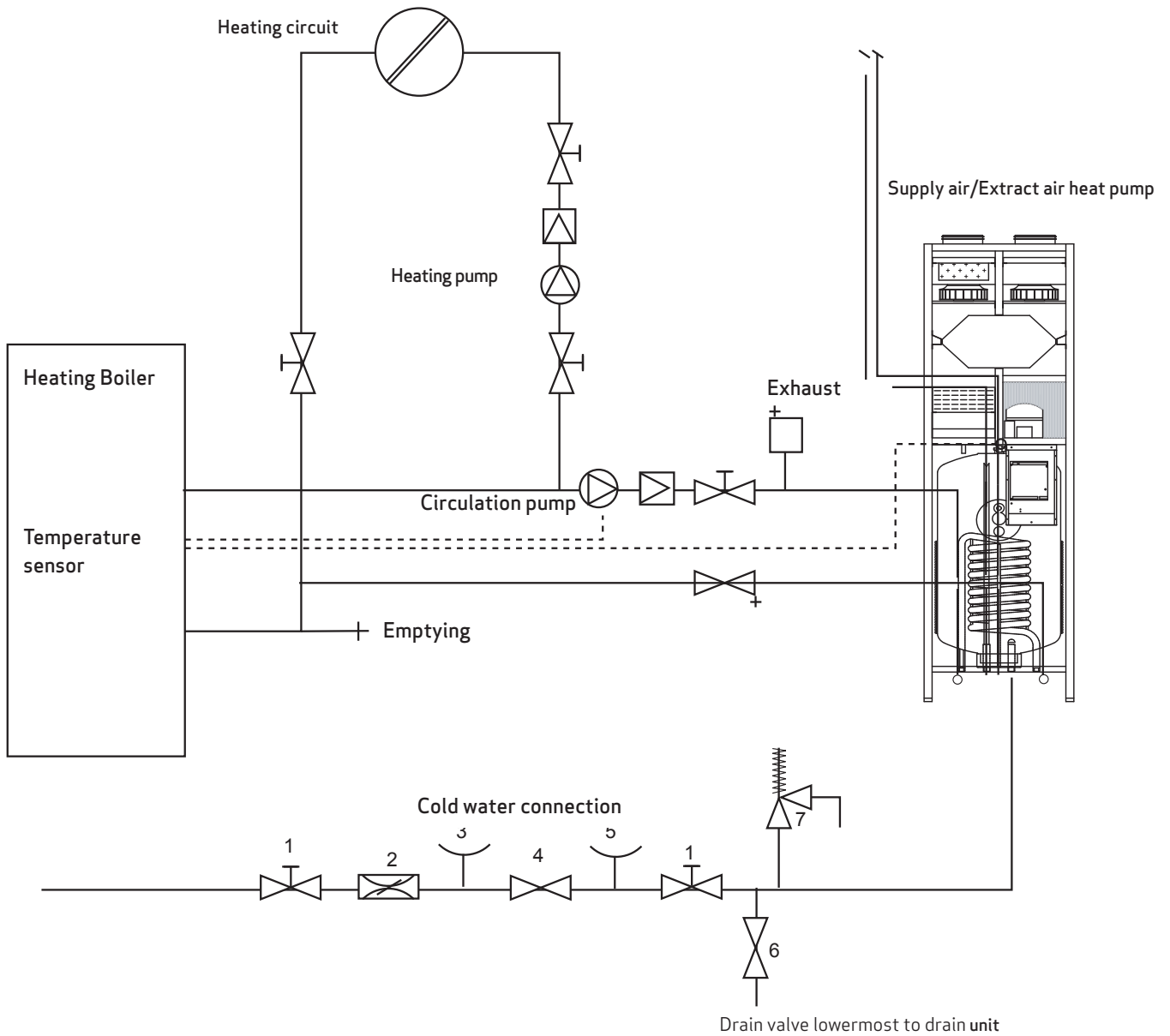

- 1: Check valve
- 2: Pressure reducing valve
- 3: Test valve
- 4: Non-return valve
- 5: Manometer connection piece
- 6: Drain valve
- 7: 6.0 bar safety valve



If you connect your heat pump to a boiler or a solid fuel boiler, make sure that the maximum temperature of the domestic hot water does not exceed 65 °C and that the pressure in the accessory heat exchanger does not exceed 3 bar! Comply with all applicable local rules, which means that deviations from the above are possible.

SPARE PARTS

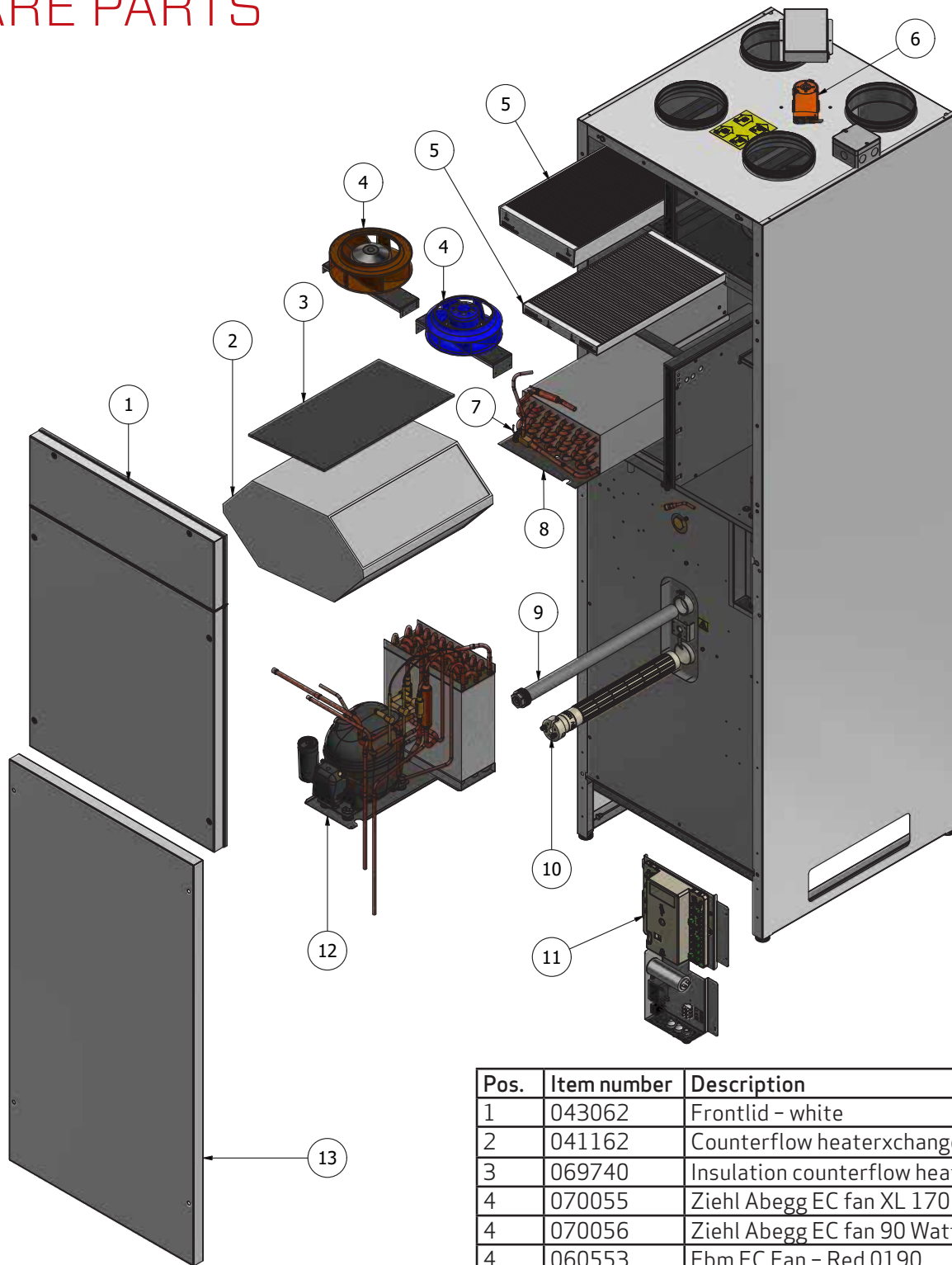

Please note:

Component configurations might vary depending on the current model. Please state the serial number of the unit when ordering spare parts.

Pos.	Item number	Description
1	043062	Frontlid - white
2	041162	Counterflow heaterxchanger - Alu
3	069740	Insulation counterflow heatexchanger
4	070055	Ziehl Abegg EC fan XL 170 Watt
4	070056	Ziehl Abegg EC fan 90 Watt
4	060553	Ebm EC Fan - Red 0190
5	060701	Filter F7/ePM1 55 % - 50 mm
5	060776	Filtech G4/Coarse 65 % - 25 mm
5	060761	Filter M5/ePM10 50 % - 50 mm
6	060536	Bypass-motor
7	061092	Expansion valve
8	040180	Evaporator assembly
9	045776	Anode
10	045724	Immersion heater
11	040146	PCB Assembly OPT 312
12	040384	Kompressor assembly LS 6210Z
12	061022	Kompressor LS - large
12	061017	Kompressor S - small
13	042897	Bottom lid - white

DECLARATION OF CONFORMITY

The declaration of conformity can be found on our website: www.genvex.com

THE AIR WE BREATHE

All
Genvex
systems are
rated with
energy label

A

Genvex develops ventilation units that use as little energy as possible, whilst still being as efficient as possible. This is good for the environment – and will also save you money. Our units comply with all applicable standards and are easy to use, install and maintain. Last – but not least – all Genvex units have compact dimensions that makes them easy to install seamlessly in all types of homes – large or small.

Genvex is a part of the Swedish NIBE Group, which has specialised in providing environment-friendly energy solutions throughout the last 70 years. The NIBE group consists of more than 140 companies all over Europe.



Genvex – the original Danish ventilation system

Genvex is a true Danish original. We started producing ventilation systems in 1978 and are still the front runners when it comes to development and production of the most innovative and durable ventilation systems on the market.

Our units are installed in thousands of homes, providing clean, fresh air free from pollen, dust and harmful particles. They help lots of families with maintaining a healthy and comfortable indoor climate and prolong the longevity of the house itself. With very high heat recovery rates, a Genvex system lets you recover and reuse up to 95 % of the heat inside your home. As a result, our units provide a strong contribution to energy savings in both in family homes and in society as a whole.

Please visit www.genvex.com to see a list of our distributors