

INSTALLATION MANUAL



GE ENERGY 1/2/3

Mechanical ventilation with passive
heat recovery

TABLE OF CONTENTS

Installation	3
Dimensions drawings GE Energy 1 and 2.....	4
GE Energy 1 – Installation.....	4
GE Energy 2 – Installation.....	5
Dimensions drawings GE Energy 3.....	5
GE Energy 3 – Installation.....	5
Duct connection.....	6
Duct system	6
Condensate drain	7
Insulation of ducts in cold loft spaces.....	7
Insulation of ducts in heated spaces.....	8
Reheating of supply air	8
Electrical installation.....	9
Inspection and initial adjustment of appliance	9
Adjustment and maintenance	10
Maintenance of the unit with the control Optima 250 DESIGN.....	10
Maintenance of the unit with the control Optima 100 DESIGN.....	10
Troubleshooting	11
Safety thermostat in electrical heating plate (optional equipment).....	11
The system is not running	11
Air faults.....	11
Alarms	11
Electrical Diagram Optima 100 Design	12
Electrical Diagram Optima 250 Design	13
Declaration of Conformity	15

INSTALLATION

When installing the units follow these instructions:

- 1) Tilt the machine 10-15 mm towards the drainpipe to allow condensing water to run to drain.
- 2) Install an airtight water trap on a non-freezing location, to compensate for fan pressure.
- 3) The water trap height **must be** at least 100 mm.
- 4) Make sure that the drain flows downwards all the way from the unit.
- 5) Pour 1 liter water into the driptray in the unit to verify that it is drained properly. Up to the heating season make sure that the drain is properly filled with water.
- 6) If freezing of the water trap may occur, it is necessary to install a thermostat and electrical heater to prevent freezing, when the temperature drops below +2C°.
- 7) Airflow adjustments must be made on both supply and exhaust sides for a normal use of the machine. It is important to have a balance between supply and exhaust air volumes
- 8) It is recommended to keep the ducts closed until the unit is adjusted and used.

KVM Genvex A/S always recommends precise planning of the set-up for your Genvex product in relation to the placement of the living space. As this refers to a technical product that includes fans and/or heat pumps, it can in rare cases, when combined with inappropriate installation conditions, result in unsatisfactory noise or vibrations. As a general rule, it is always recommended that the technical unit be installed so that it is not placed in the immediate vicinity of a bedroom. It is also recommended that the Genvex unit be secured to the building construction – i.e. fixed to a heavy foundation such as concrete. It must also be ensured that no transfer of sound or vibrations through materials that are in contact with the technical unit can take place. If there is a risk of reproduction of noise or vibrations, additional installation of vibration damping materials is recommended as well as soundproofing of the set-up space.

This instruction must be followed. If the drain is not made according to this instruction, GENVEX A/S can not be made responsible for any additional damages, which have nothing to do with the GENVEX unit.

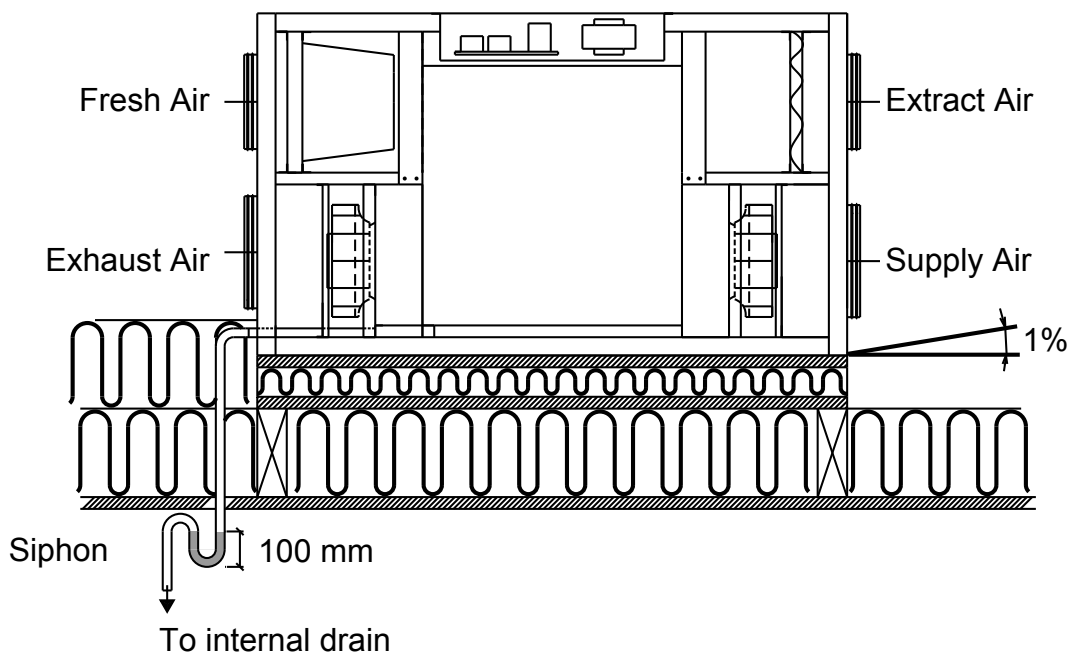

Lack of water in siphon = water damage

Dimensions drawings GE Energy 1 and 2

Dimensions in mm

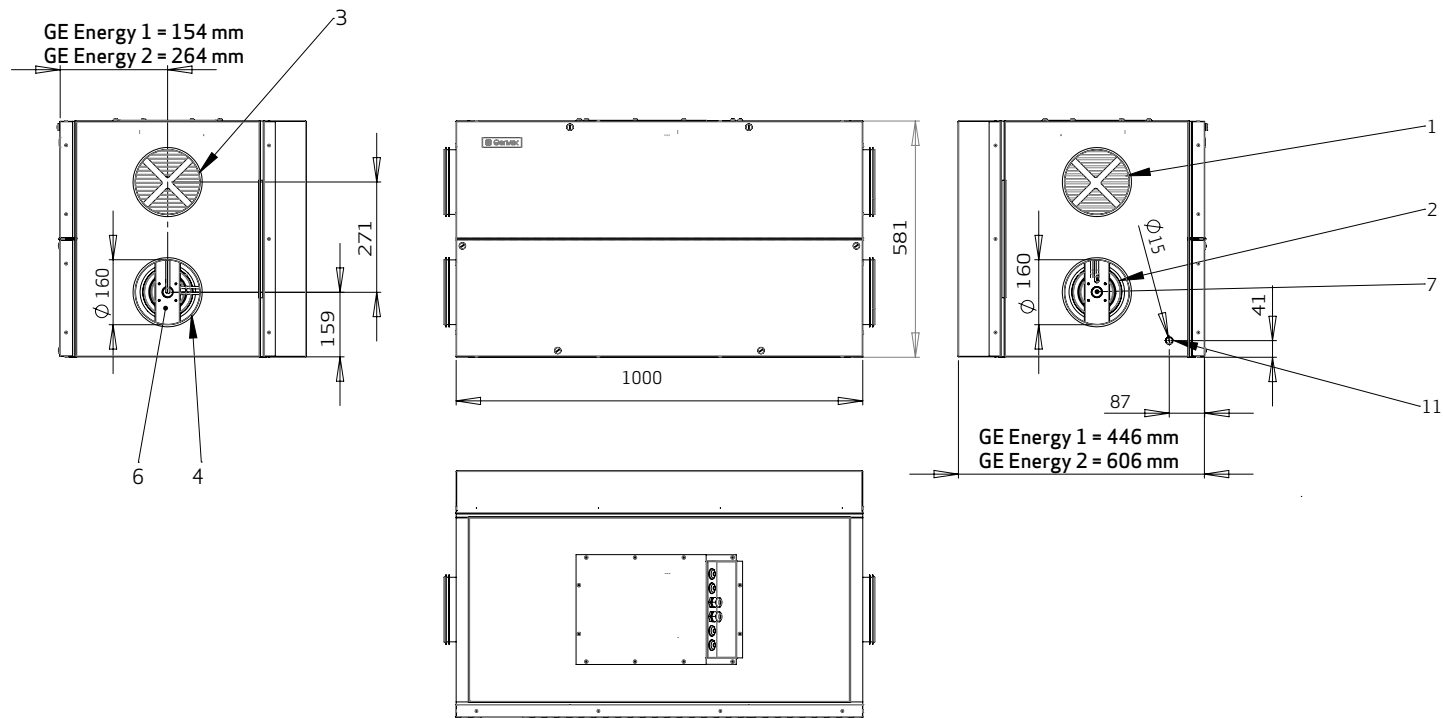

1. Fresh (external) air
2. Exhaust air
3. Extract air
4. Supply air
5. Countercurrent heat exchanger
6. Supply fan
7. Extract fan
8. Fresh air filter
9. Extract filter
10. Condensate tray
11. Condensate outlet
12. Electrical connection
13. Bypass

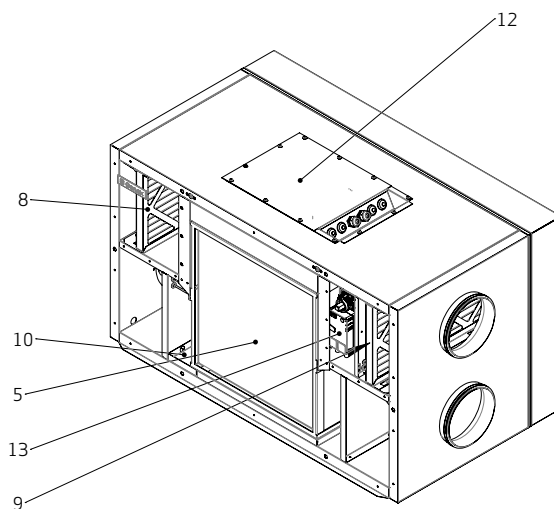

GE Energy 1 - Installation

The unit must be positioned on a subsurface such that vibrations from the unit cannot be transferred down through ceiling and walls and such that the condensate drain with the necessary trap can be led to an internal drain without danger of freezing in cold weather, as in the winter period a unit may produce up to 8 litres of condensate per day.

To allow access for service and maintenance, there must be a clear space of a minimum of 600 mm in front of the unit. If the unit is located in the loft, there must be free access to the unit from the loft hatch.

Bypass

The GE units can be delivered with modulising bypass or it can be mounted on site.

Weight: 55 kg

GE Energy 2 - Installation

The unit must be positioned on a subsurface such that vibrations from the unit cannot be transferred down through ceiling and walls and such that the condensate drain with the necessary trap can be led to an internal drain without danger of freezing in cold weather, as in the winter period a unit may produce up to 8 litres of condensate per day.

To allow access for service and maintenance, there must be a clear space of a minimum of 600 mm in front of the unit. If the unit is located in the loft, there must be free access to the unit from the loft hatch.

Bypass:

The GE units can be delivered with modulising bypass or it can be mounted on site.

Weight: 84 kg

- | | |
|----------------------------------|----------------------------|
| 1: Fresh (external) air | 7: Extract fan |
| 2: Escaping air | 8: Fresh air filter |
| 3: Extract air | 9: Extract filter |
| 4: Supply air | 10: Electrical cabinet |
| 5: Countercurrent heat exchanger | 11: Condensate tray |
| 6: Supply fan | 12: Condensate drain 15 mm |

Dimensions drawings GE Energy 3

Dimensions in mm

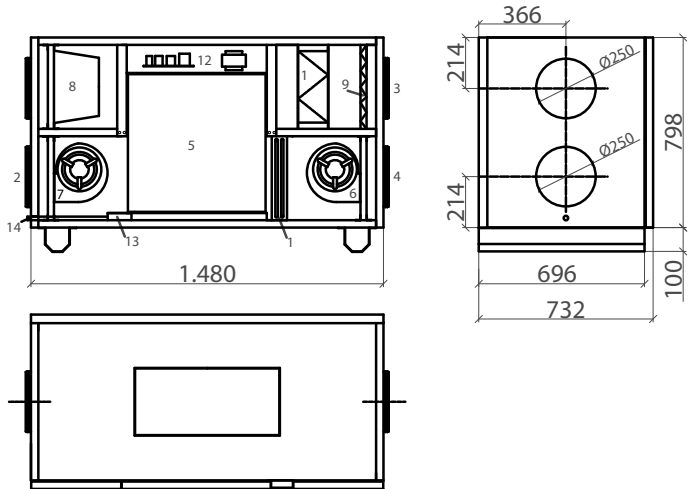

- | | |
|----------------------------------|----------------------------|
| 1: Fresh (external) air | 8: Fresh air filter |
| 2: Escaping air | 9: Extract filter |
| 3: Extract air | 10: Electrical cabinet |
| 4: Supply air | 11: Condensate tray |
| 5: Countercurrent heat exchanger | 12: Condensate drain 15 mm |
| 6: Supply fan | 13: By-pass damper |
| 7: Extract fan | 14: Water-based reheating |

GE Energy 3 - Installation

The unit has supports and can be installed directly on a vibration-free solid sub-surface. If oscillation dampers are provided (extra equipment), these should be mounted under the supports. In addition it must be ensured that the condensate drain with the necessary trap can be led to an internal drain without danger of freezing in cold weather, as a unit may produce up to 8-10 litres of condensate per day.

To allow access for service and maintenance, there must be a clear space of a minimum of 700 mm in front of the unit. If the unit is located in the loft, there must be free access to the unit from the loft hatch.

The units are installed with bypass.

Weight 185 kg

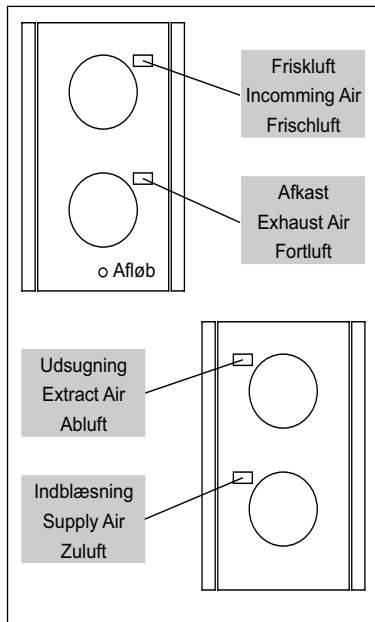

Duct connection

All duct connections display a yellow sticker indicating the type of ventilation channel to be connected.

Connect the supply air

Duct system from the unit to the supply outlet in the living room.

Connect the extract air

Duct system from wet rooms to the unit.

Connect the fresh air

Duct system from fresh air roof cowls/external grills from the ground collector to the unit.

Connect the exhaust air

Duct system from unit to the escaping roof cowls/external grills.

Duct system

It is recommended that the duct system is executed in spiral ducting connected with rubber ring seal fittings in order to provide a leak-free and durable duct system.

To achieve a satisfactory low sound level from the unit, sound locks must always be fitted to the supply and extract duct system between the unit and the first supply and extract fittings.

It is recommended that air speeds in the ducts are dimensioned at sufficiently low level to prevent noise from the supply and extract fittings.

When positioning fresh air and extract roof cowls/grills, make sure the two air flows do not intercept, causing escaping air to be drawn in again.

It is recommended that grills are placed on the north or east side of the house to provide optimum comfort.

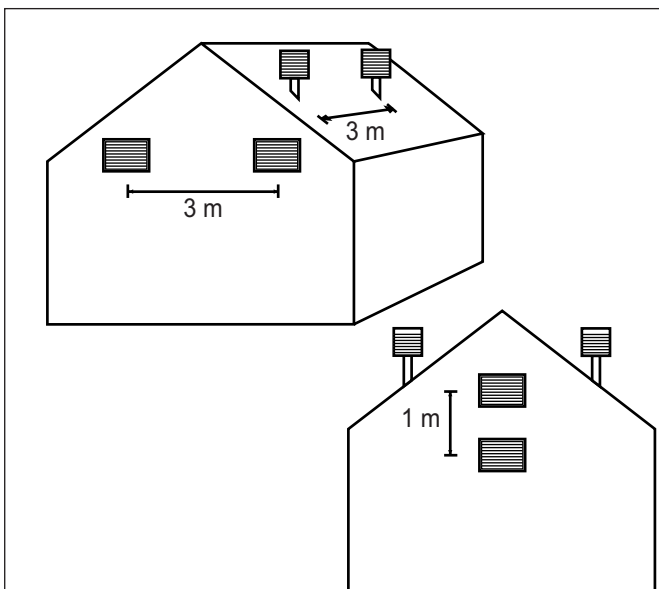

GE Energy 1, 2 and 3

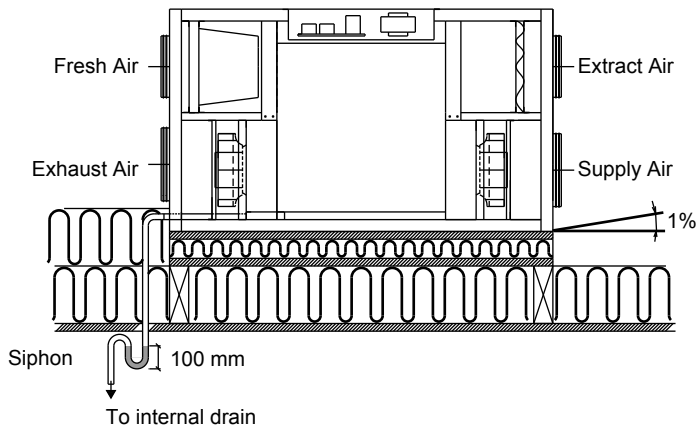

Lack of water in siphon = water damage

Condensate drain

The units produce up to 10 litres of condensate per day. It is therefore important that the condensate drain is correctly executed and that the unit has a slight fall towards the condensate drain.

The condensate drain pipe must be air tight for example by bending a copper pipe as an siphon (see sketch to the left). Use an armed water hose between the drain connecting piece on the unit and the siphon and tightend it in both ends with a collar band.

From the siphon and to the internal outlet there must be a necessary fall on 1%. The condensate drain must be fitted with a water trap as there is negative pressure in the chamber in which the condensate tray is mounted.

If the unit is installed in a cold loft space, the condensate drain pipe must be insulated to prevent freezing of the condensate in the pipe. However, it is recommended that the water trap is installed in a heated space below to ensure that the water in it does not freeze.

If installation problems make it impossible to secure the condensate drain pipe from freezing by insulation, it will be necessary to mount a thermostat-controlled heating tape round the condensate drain pipe.

Insulation of ducts in cold loft spaces

In order to exploit the unit's high recovery potential (efficiency), it is necessary to insulate the ducts correctly.

Genvex recommends as follows:

Supply and extract ducts

To minimise heat losses from the duct system in cold loft spaces, the supply and extract ducts must be insulated with a minimum of 100 mm insulation. If insulation form alternative A is used, it is recommended that it is executed with two layers of 50 mm lamella mats with paper or foil externally and with staggered joints between the two layers. If the ducts are laid on the rafter foot, alternative B may be used. The insulation must always be tightly packed round the ducts.

Fresh air and escaping ducts in cold spaces

It is recommended that fresh air and escaping ducts are insulated with a minimum of 50 mm insulation. The fresh air duct is insulated to prevent warm air in the loft in summer from heating up the fresh air. Take care to seal the termination where the escaping duct is led through the roof or through the gable end, in order to avoid condensation damage.

Refer to your local distributor for guidance on national insulation directives.

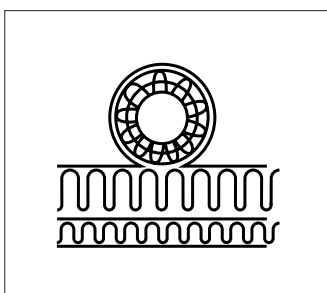

Duct insulation, alt. A

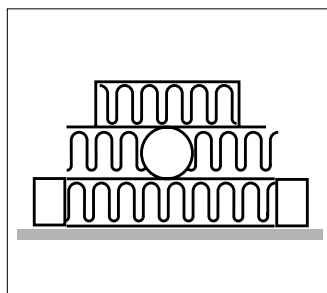

Duct insulation, alt. B

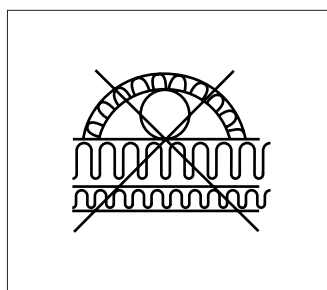

Faulty duct insulation

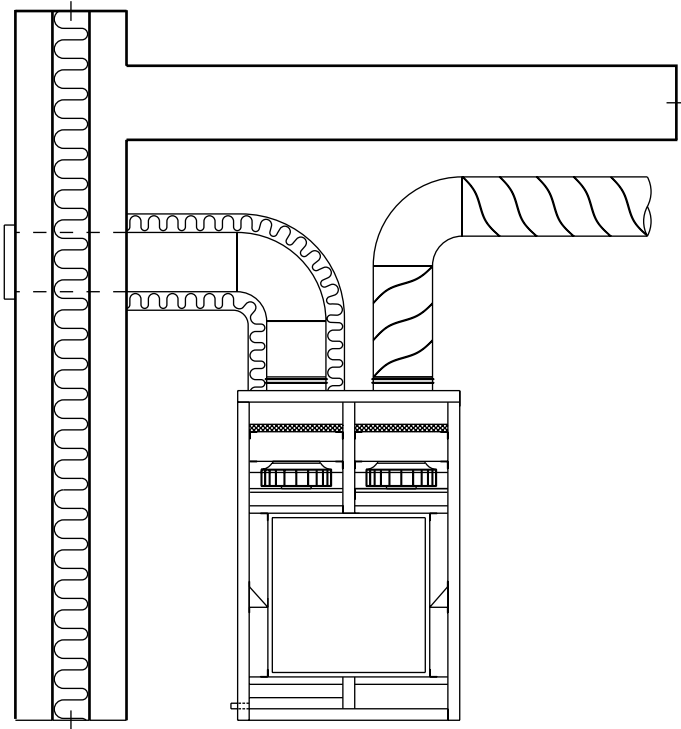

Insulation of ducts in heated spaces

Genvex recommends as follows:

Supply and extract ducts

In warm loft spaces the supply and extract channels must be insulated with 50 mm insulation. Supply and extract air ducts led through heated spaces in dwellings do not require insulation. If the supply air duct has cooling, bypass or earth heat exchanger installed it must be insulated.

Fresh air and exhaust ducts

In warm loft spaces and warm rooms in dwellings the fresh and exhaust air ducts must be insulated with minimum 50 mm insulation. In addition, the insulation must be covered externally with plastic film or aluminium foil in order to avoid condensate in the insulation.

We recommend an insulation of 100 mm on the fresh air duct when installing a earth heat exchanger.

Refer to your local distributor for guidance on national insulation directives.

Reheating of supply air

As the counter current heat exchanger cannot extract all the heat from the extract air and supply it to the supply air, the supply air will be about 1-4°C colder than the room temperature in the dwelling for the whole winter season. If this lower supply temperature is insupportable during cold periods, a water-based or electrical reheating surface can be mounted for reheating the supply air up to room temperature.

Water-based reheating surface

To protect the water-based reheating surface from frost burst, a frost protection thermostat must be fitted to the unit and the surface insulated. The frost protection thermostat sensor is mounted behind the fins of the water-based reheating surface. The sensor for controlling the motor valve is mounted in the supply air channels approx. 500 mm downstream of the water-based reheating surface in order not to be affected by the radiant heat from the heating element. The water supply to the water-based reheating surface must be executed by an authorised plumbing and heating engineer.

Electrical reheating surface

The sensor for controlling the electrical heating surface is mounted in the supply air channel approx. 500 mm downstream of the electrical reheating surface in order not to be affected by the radiant heat from the heating element.

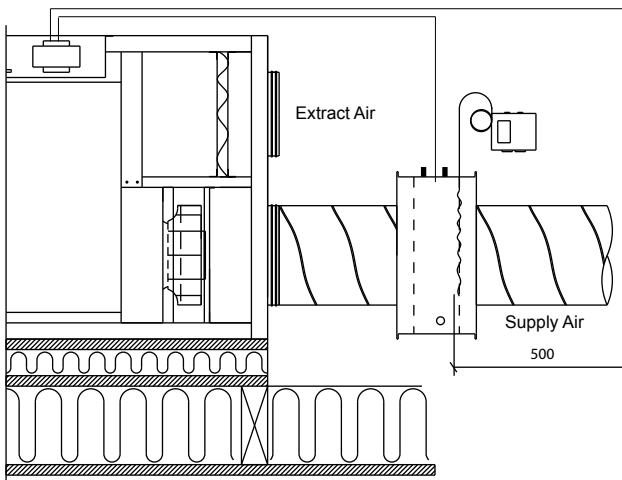

With water-based reheating surface

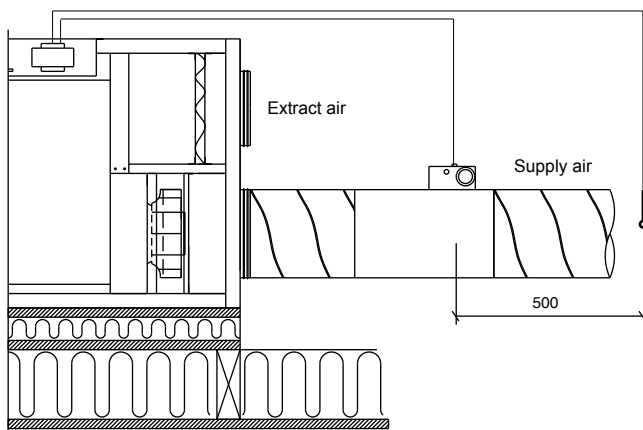

With electrical reheating surface

Electrical installation

The electrical connection must be carried out by an authorised electrical engineer.

See accompanying electric diagram.

The cable between the unit and the control panel is a 4-conductor cable for Optima 250, with a maximum length of 50m and a 8-conductor cable for Optima 100 with a maximum length of 10m.



Inspection and initial adjustment of appliance

To achieve optimum running of the unit it must be initially adjusted with air measuring equipment.

To start up the unit before adjustment, do as follows:

Before starting up the unit:

1. Check that the Genvex unit is correctly mounted and that all ducts are insulated as required.
2. Check that hatches can be opened so that service and maintenance on the unit can be carried out.
3. Check that filters are clean (may be dirty from installation work).
4. Check that the condensate drain is correctly mounted with water trap and is protected from freezing. Pour 1 litre water into the condensate tray and make sure it can run unhindered through the condensate drain pipe.
5. Set all supply valves such that the valve closest to the unit is opened three turns from closed position, while the furthest is open eight turns from closed position. Open the intermediate valves by 4-7 turns depending on how far they are from the unit.
Set all extract valves so that the extract valve in the kitchen opens 8 rounds, the extract valve in the bathroom/toilet 7 rounds and the extract valve in the utility room opens 6 rounds from closed position.
6. If a reheating surface has been mounted on the unit, set the supply temperature to 0-3°C below the room temperature in the dwelling.

The unit can now be started up and be allowed to run until initial adjustment with air measurement equipment has taken place.

ADJUSTMENT AND MAINTAINANCE

Air measuring equipment is used.

Before starting initial adjustment, check that the 6 points in the chapter „Inspection and initial adjustment of appliance“ have been carried out. Then start up the unit.

Maintenance of the unit with the control Optima 250 DESIGN



Turn off the electricity for the unit before opening it

Filters

When the filter timer reaches the set value for filter change, „Alarm!“ will show in the screen saver and „Chg. filter“ will flash. This means that it is time to clean/change the filters.

Stop the unit on the power switch of the unit or at the board. Open the front panel and take out the filters. After changing the filters, switch off the filter timer.

If you want to change the interval for cleaning the filters, this can be adjusted in the User menu.

Maintenance of the unit with the control Optima 100 DESIGN



Turn off the electricity for the unit before opening it

Filters

When the LED D5 for changing the filters flashes in the display on the control panel, the filters must to be changed.

Stop the unit on the power switch of the unit. Change the filters and reset the filter timer.

If you want to change the interval for cleaning the filters, this can be adjusted in the operating instructions under section 3.3 Filter alarm.



Do not vacuum or clean at high air pressure. It will damage the filter!

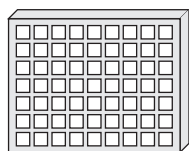

G4 = Standard filter
(Coarse filter class G4)
F5 = Fine filter (Fine filter class F5)
F7 = Pollen filter (Fine filter class F7)



Careful handling of the plates is required. They have sharp edges and must not be damaged.

GE Energy 1, 2 and 3

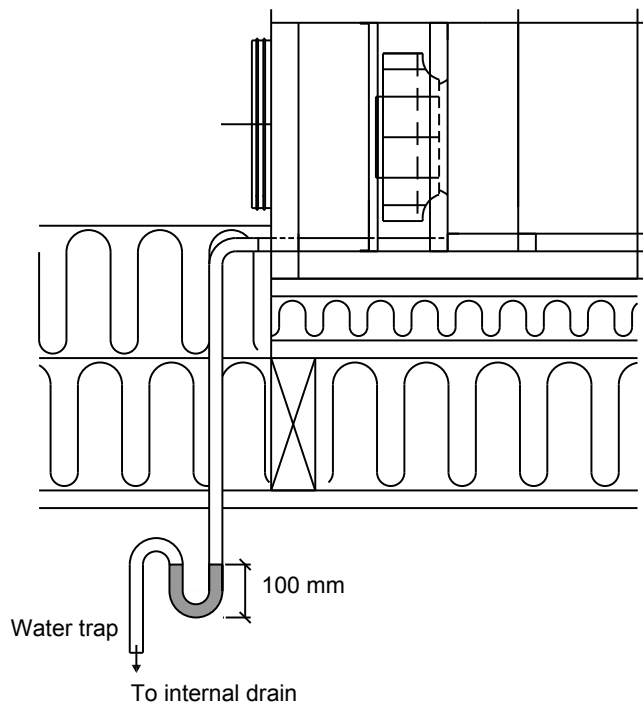

Condensate drain

When changing the filter in August/September, before outside temperatures falls to 5°C, check the condensate drain for blockage by dirt and check that there is water in the water trap.

Pour 1 litre water into the condensate tray and make sure it can run off without problems. If the condensate drain does not work, this could lead to water damage in the dwelling.

Countercurrent heat exchanger

Inspect the countercurrent heat exchanger every year. If it is dirty, remove it and wash in warm soapy water and then rinse, possibly in the bathroom using the shower head.

Fans

Every year check the two fan wheels for dirt. If they are dirty they may be cleaned with a brush, bottle washer etc. Remember to shut down the power.

Supply and extract valves:

Clean the valves by wiping with a dry cloth. Make sure the valve does not rotate, causing a change in the air volume.

Service

If you are unable to maintain your unit yourself, you can sign a service agreement with the Genvex service department. If any faults arise in the unit, contact the Genvex service department.

TROUBLESHOOTING

Safety thermostat in electrical heater (optional equipment)

If an error occurs on an electrical heater, the safety thermostat will disconnect.

The heater is equipped with a fire thermostat that automatically cuts off the power supply, if the temperature exceeds 80 °C. If the temperature decreases, the heater automatically re-engages.

As an additional security there is a built-in thermal cut-out, which disengages if the temperature exceeds 110 °C.

Re-engaging must be done manually.

Does not apply to PTC electrical heaters.

The system is not running

Unit stopped

Possible error:

- Fuse in main board has blown, no power to unit.
- One of the fuses on the circuit board of the unit is blown.
- Loose wire, no power to unit.
- Loose wire between unit and control panel.
- Faulty or incorrectly set week program.
- Filter timer has switched the system off.

Condensed water is leaking from the unit

Possible error:

- Condensation outlet blocked by dirt.
- The condensation outlet is not adequately protected against freezing at low outdoor temperatures.

Air faults

No supply air

Possible error:

- Faulty supply air fan
- Clogged supply air filter
- Clogged fresh air grill due to dirt and leaves during the fall and snow and ice during the winter.
- Fuse on the circuit board is blown.
- The unit is in defrost mode (supply air fan stops)
- Incorrect value set in User menu item 2.

No extract air

Possible error:

- Faulty extract air fan
- Clogged extract air filter.
- Fuse on the circuit board is blown

Cold supply air

Possible error:

- Clogged heat changer.
- Faulty extract air fan.
- Clogged extract air filter.
- Electrical reheater is disconnected at the over heating thermostat (only units with electrical reheater installed).
- Air in the heating pipes, faulty thermostat / motorvalve, incorrect setting of control panel

If it is not one of the above errors, please contact

• **Within the guarantee period (0-2 years):**

The installer from whom you have bought the system.

• **After the guarantee period (2 years ->):**

The installer from whom you have bought the system or the Genvex service department (+45 7353 2765).

Before calling, please write down the data from the inscription plate (silver plate on the unit).

Alarms

Filter timer

The control has a filter timer to guarantee that the filter is changed and that optimal operation is established. When the timer reaches the set value, "Chg. filter" will flash in the display until the filters have been changed.

When the filters have been changed, the button for the filter symbol must be held down until "Alarm!", "Chg. Filter" and the exclamation mark disappears and the unit reverts to normal operation.

Com error

This error appears when there is no communication between the display and control. Check that the wiring is correct on terminals 21 to 24.

21	Signal
22	Signal
23	10 Volt
24	0 Volt

Frost protection error

This error message will be displayed if a water reheater is fitted to the system and the temperature of the water reheater is too low, causing a danger of frost burst. The control will stop the system and open the motor-operated valve to keep the heater warm.

ELECTRICAL DIAGRAM - OPTIMA 100 DESIGN

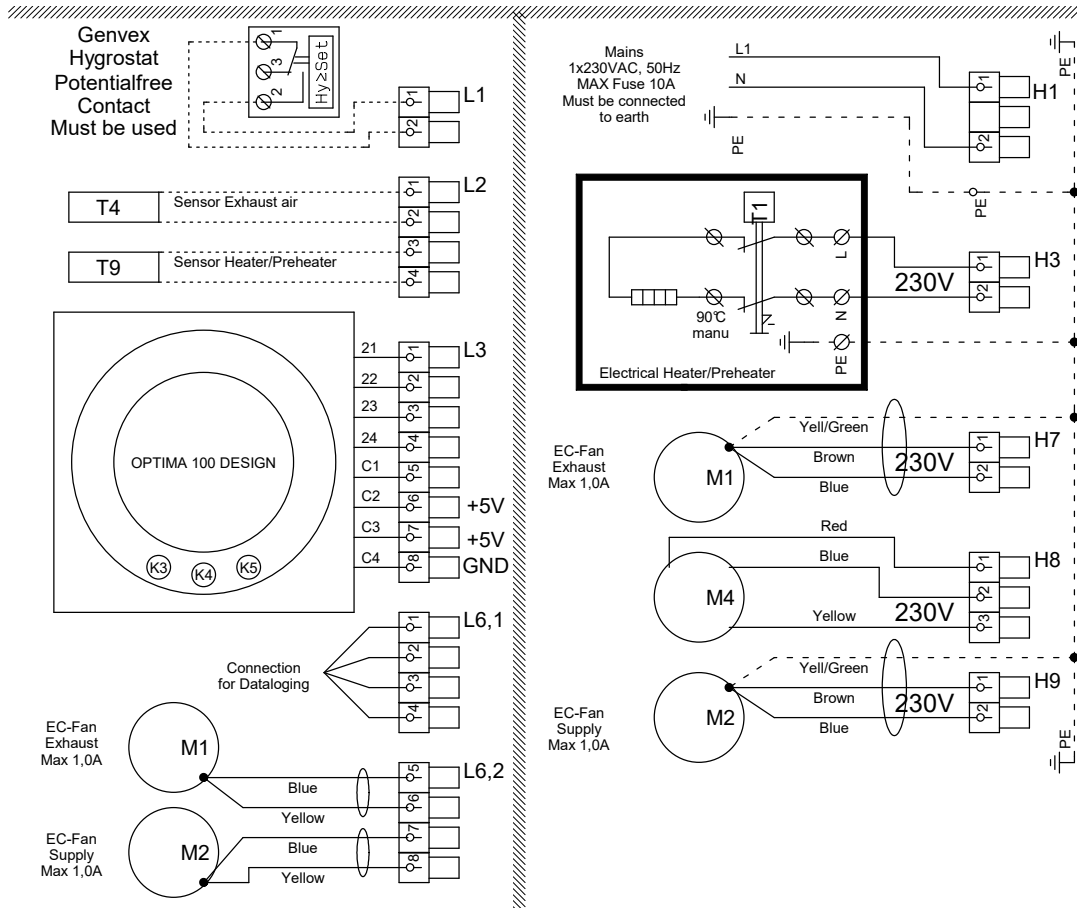
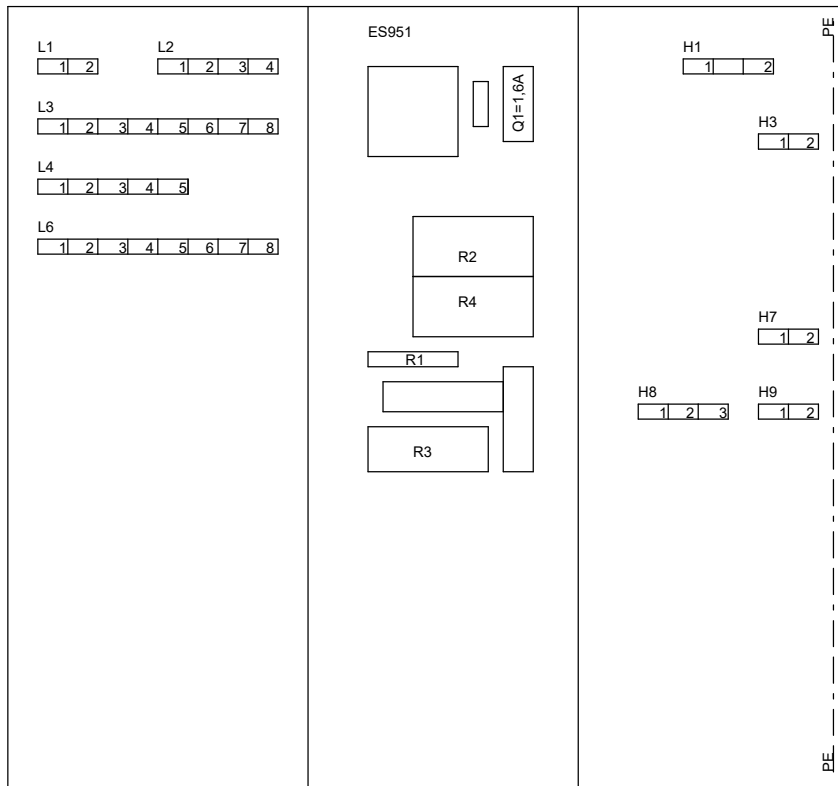

- L1** = Hygrostat
- L2** = T4 Sensor exhaust air
T9 Sensor heater/preheater
- L3** = Display
- L6,1** = Datalogging
- L6,2** = Exhaust and supply fan
- H1** = 230V
- H3** = Electrical heater/preheater
- H7** = Exhaust fan
- H8** = Bypass
- H9** = Supply fan

ELECTRICAL DIAGRAM - OPTIMA 250 DESIGN

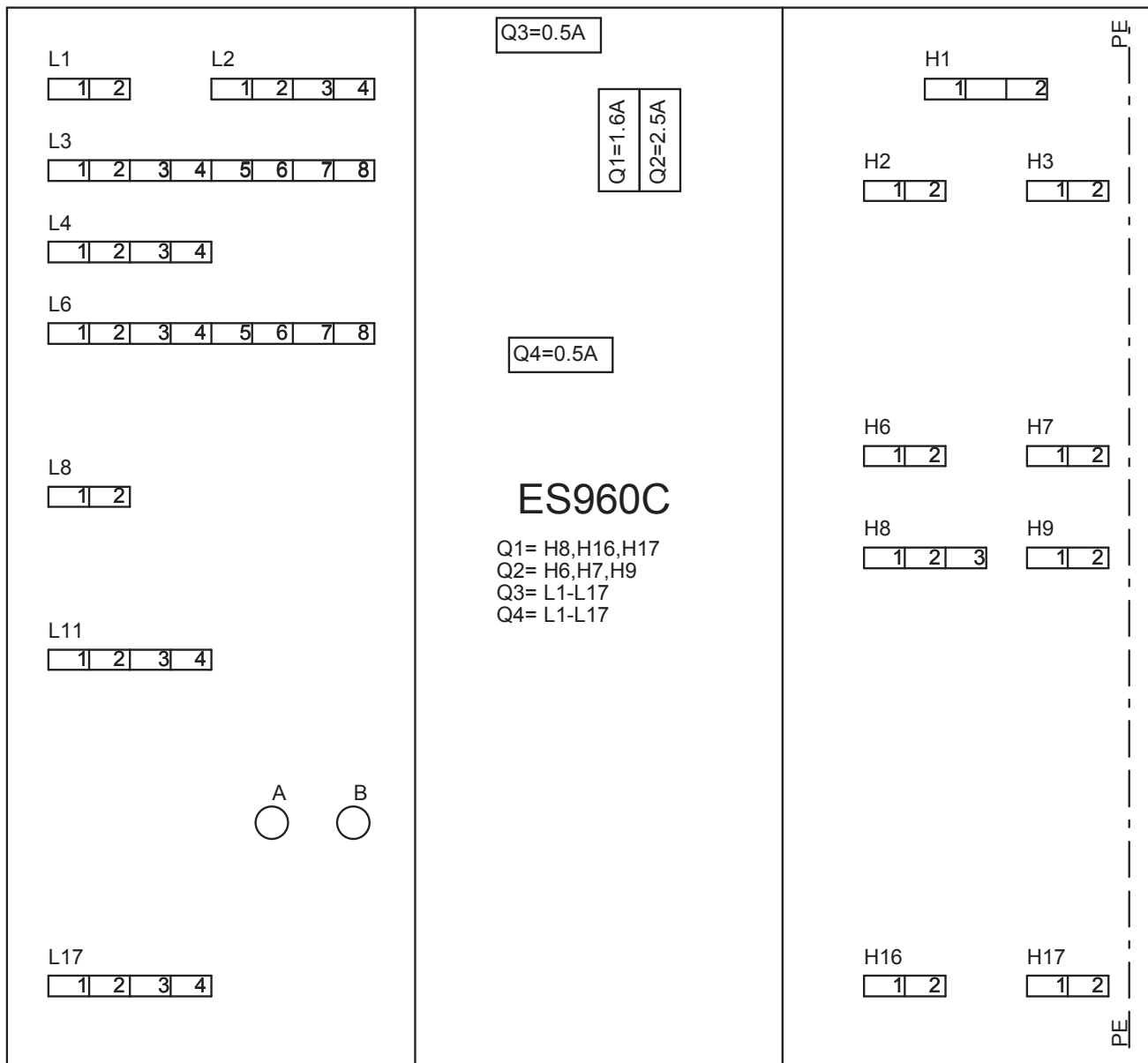

Q=Fuse

L1 =Humidistat
 L2 =Display
 L3 =Sensors T1,T3,T4,T7
 L4 =Humidity sensor P1
 L6 =Sensors T8,T9
 L8 =External stop
 L11=0-10V Water valve and
 0-10V Belimo bypass
 L17=0-10V extract air fan and
 0-10V supply air fan

H1 =Mains connection 230 VAC
 H2 = (R2) Electric Reheater 230VAC
 H3 = (R3) Electric Preheater 230VAC
 H2,H3 =Max. load total 1800W COS Φ 1
 H6 = (R10) Water valve, Belimo Bypass 230VAC
 H7 = (R10) Fan, extract air 230VAC
 H8 = (R12) ON/OFF Bypass 2x230VAC
 H9 = (R10) Fan, supply air 230VAC/bypass
 H16= (R8) AUX relay 230VAC max. 20W
 H17= (R9) AUX relay 230VAC max. 20W

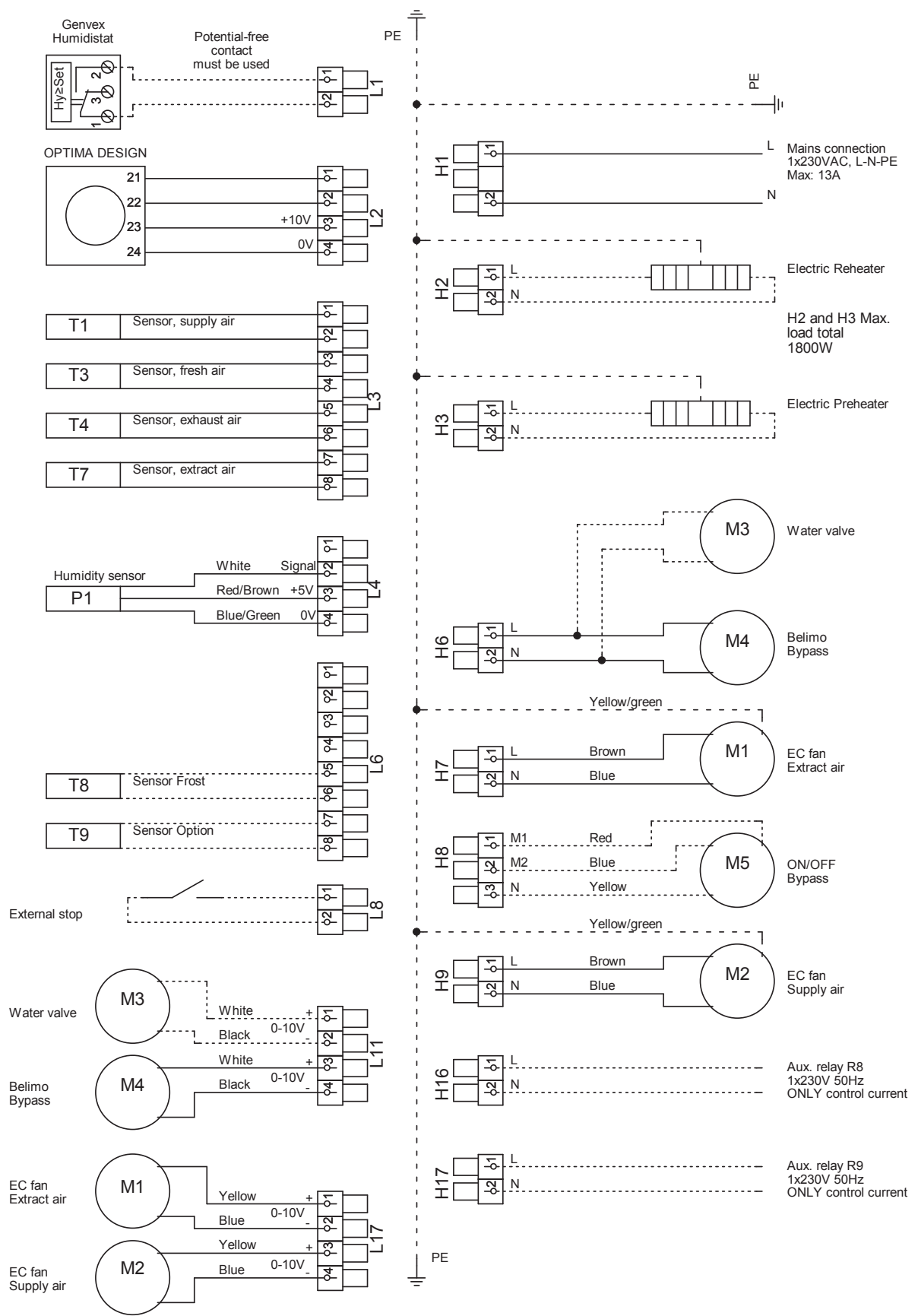

21-08-2014

DECLARATION OF CONFORMITY

The declaration of conformity can be found on our website: www.genvex.com.

THE AIR WE BREATHE

All
Genvex
systems are
rated with
energy label
A

The original Genvex units are assembled by skilled and experienced technicians and have a lifetime that in many cases is measured in decades. The units are approved by all applicable standards and are easy to operate and service. Last – but not least all Genvex systems are developed with focus on compact dimensions and ease of installation and can be integrated discreetly in all types of homes.

We are part of the NIBE Group – a family of companies that specialize in supplying hot water, heating and home comfort to homeowners worldwide.

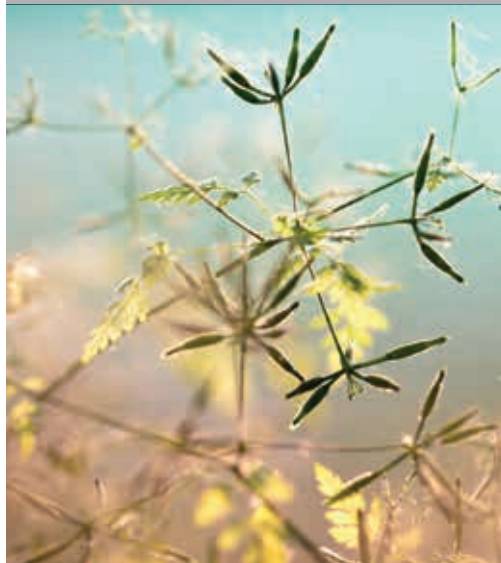

Genvex – The original Danish Ventilation System

Genvex is a genuine Danish original. We invented the ventilation system more than 40 years ago, and we are still ahead of the pack when it comes to development and production of the strongest and most durable ventilation system.

Our unit is working in thousands of homes providing fresh clean air – free of pollen, dust and harmful particles. This helps to strengthen the health of the house and to make the indoor environment healthy and comfortable for lots of families. At the same time, our system is an important element when it comes to saving energy in homes and in society as a whole – in fact you can recover up to 95% of the heat energy with a Genvex system.

Please visit www.genvex.com to see a list of our distributors.

